

FW2-PIRCAM-N IN 8F/9F



FREEWAVE™ TWO WAY WIRELESS INDOOR PIRCAM DETECTOR



INSTALLATION INSTRUCTIONS

P/N 7105088 _D

FW2-PIRCAM INDOOR FEATURES

The FW2-PIRCAM-N IN is a two way wireless motion detector with a built-in CMOS high quality color camera that provides the perfect solution for visual alarm verification of your premises.

When your control panel is armed and the PIR sensor detects movement, the detector sends an alert and transmit picture to the CMOS or to your mobile phone.

- Freewave2 Advanced & Secured RF protocol
- Pet immune passive IR detection element
- Low current Technology
- Tamper Open/Close transmission
- Unique ID number
- 110 degrees lens- mounted in factory
- CMOS camera with CIF resolution
- 2 DSP microcontrollers for image processing
- IR LEDs for operating in low light conditions.
- Red indicator LED

OPERATION

The Wireless FW2-PIRCAM-N IN detector transmits the following events data:

SUPERVISION - a periodical preprogrammed transmission indicates detector's presence.

SNAPSHOT IMAGES – a preprogrammed 1-5 images transmission on motion detection

ALARM - Alarm transmission triggered by PIR intrusion detection.

LOW BAT – Whenever the battery reaches a pre-set low level (~2.6V) Battery Low signal will be sent with the next scheduled message (Supervisor, Alarm, etc.).

TAMPER – Whenever the cover is removed or placed back, a message will be transmitted with "Tamper" signal.

FIG. 1 - REMOVAL OF FRONT COVER

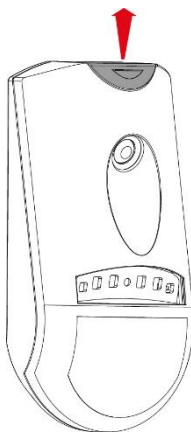

FIG. 1 - REMOVAL OF FRONT COVER

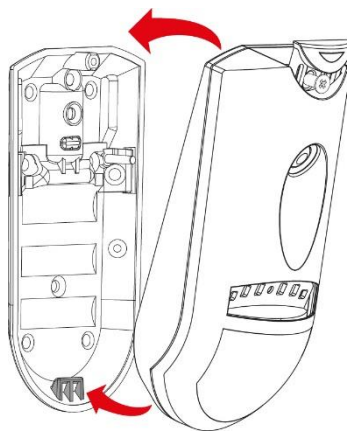

FIG. 2 -PIRCAM BASE INSTALLATION

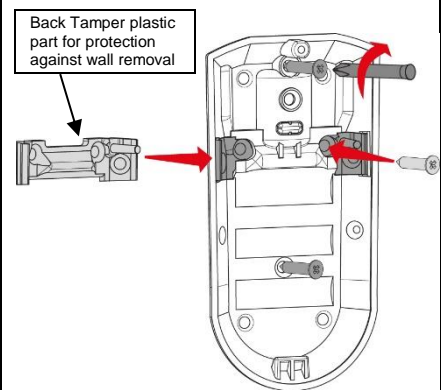
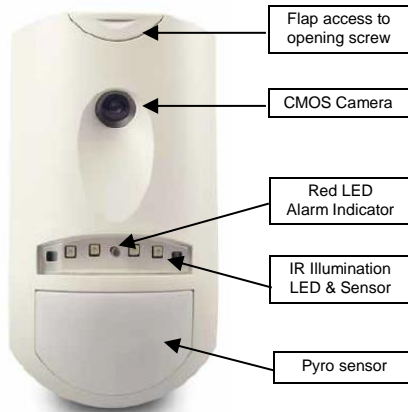

FIG. 3 – PHYSICAL DESCRIPTION



LEARNING THE DETECTOR

This section describes and explains how to learn and set the configuration of FW2-PIRCAM-IN N.

3 options for PIRCAM learning:

1. By detector ID (the ID appears on the lower side of the barcode sticker attached to the product)
2. From PC application (refer to app manual).

LEARNING THE DETECTOR

Learning on Shepherd™ Control Panel:

1. Login to installer mode via installer web page.
2. Go to Zones level
3. Select the required zone number for learning.
4. Add Zone: Insert link type "ISM", Enter the unique ID of the device, Device Type "Camera PIR".
5. Set and Save the Configuration.
6. Insert the 3 batteries into Camera.
7. Verify Green & Red are blinking alternately, then the LED will turn Green on for 3 sec. to indicate device learned successfully.
8. If Green LED continues flashing more than 5 minutes and stopped, please check PIRCAM settings details, remove batteries and repeat steps 4,5.

RSSI – RF SIGNAL INDICATION

The control panel has "RF Signal Strength Indication" (RSSI) for each transceiver in order to help the installer to define the best location for the detector from RF perspective.

The RSSI range indicator for shepherd panel presented as an icon notification bar. RSSI icon display can be found in Zone and Overview level. The range is between 0-1 bar (low signal) to 5 bars (high signal).

Ex. 5 Bars Zero no signal

The indication value is between 1 and 100, for SERENITY panel where 100 is the best RF received signal. If the RSSI indication value is less than 30, it is a sign for a weak RF link and it is recommended to find a better installation for the

SELECT MOUNTING LOCATION

The FW2-PIRCAM-IN N should be mounted at 2.1m for optimal detection.

Choose a location most likely to intercept an intruder.

See detection pattern. The detector detects motion crossing the beam; it is more sensitive detecting motion crossing the beams then moving toward the detector.

SELECT MOUNTING LOCATION

AVOID THE FOLLOWING LOCATIONS

- Facing direct sunlight.
- Facing areas that may change temperature rapidly.
- Areas where there are air ducts or substantial airflows.

The FW2-PIRCAM-IN N performs better when provided with a constant and stable environment.

MOUNTING THE DETECTOR

- To remove the front cover, unscrew the holding screw and pull out the cover by tilting from bottom out.
- Mount the detector base: place 4 screws and make sure you tighten the tamper screw (the middle screw) easily, so the back tamper switch will press the switch successfully when PCB is placed back - over winding may result in false mechanical adaptation and lack of tamper press.
- Place the CR123A batteries confirming the correct polarity.
- Place the cover by inserting it back into appropriate position and tilting bottom side in.
- Fasten the holding screw.

16

INSTALLATION LOCATION

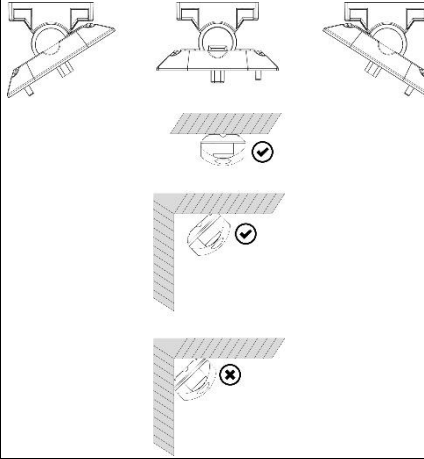

17

TRANSMISSION TESTS

Tamper transmission test

Change of the tamper switch state will cause tamper transmissions. Verify it on the control panel indications.

Communication signal test

Check the RF Communication quality (RSSI). Special indication at the control panel that displays continuously the received RF signal quality.

Walk test

Make sure that the protected area is cleared of all people 3 minutes before starting the walk test. Initialize the "Walk test" mode on your control panel. Start walking across the detection zone. Listen to ALARM sound whenever motion is detected (the red LED also turns ON whenever motion is detected). Allow 5 sec. between each test for the detector to stabilize.

18

DETECTION PATTERN

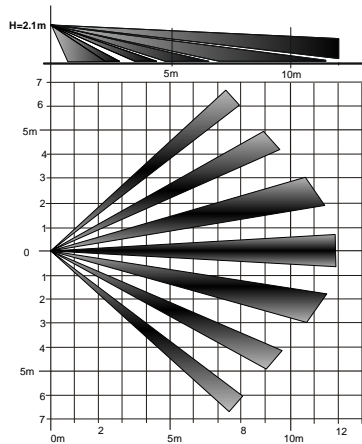

19

BATTERY REPLACEMENT

Battery can be replaced by user

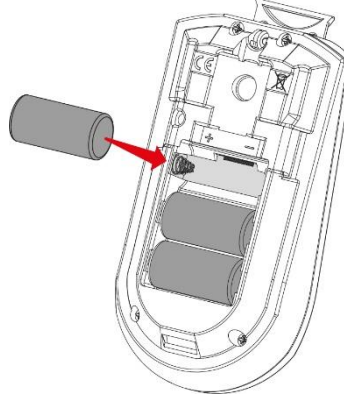

20

CAUTION !!!

RISK OF EXPLOSION IF BATTERY IS REPLACED BY DIFFERENT TYPE / MODEL.
DISPOSE USED BATTERIES ACCORDING TO ITS INSTRUCTIONS

The battery must be replaced by 3V Lithium battery Size 2/3A Models such as:

- VARTA CR123A
- GP CR123A

Power supply Type C

21

REGULATORY APPROVALS

Environmental parameters

- Class II
- Operating temperature -10° - 55°
- Relative humidity – RH 85% non-condensed

Device Standard Compliance

Security Grade2

- EN 50130-4
- EN 61000-6-3
- EN 301 489-3
- EN 301 489-1
- EN 300 220-2
- EN 300 220-1
- EN 60950-1
- EN 50131-5-3
- EN 50131-1
- EN 50131-2-2
- EN50131-6
- EN50130-5

Manufacturing Standards Compliance

- ISO 9001:2000
- RoHS 3 (EU Directive 2015/863)

Certification body: Telefication B.V.

22

TECHNICAL SPECIFICATIONS

Detection Method	Quad Element PIR & CMOS Camera for visual verification
Data Protocol	Freewave2™ Two Way Protocol
Modulation Type	2GFSK
Frequency Band	868-869MHz / 916-917MHZ
Identification	Unique ID serial number – 24 bit
Event Transmission	Alarm, Picture(s) Verification, Tamper, Supervision, Low Bat Supervision
LED Indication	LED during alarm
Tamper Switch	Front Cover and Removal
Communication Range in open space	500m

TECHNICAL SPECIFICATIONS

Camera	CMOS camera with CIF or VGA resolution
Picture Range	12m
CMOS Sensitivity	16VLux/sec
Picture Mode	Configurable B&W / Color
Resolution	Configurable VGA / QVGA
Current Draw	Receive mode – 26mA Transmit mode – 50mA
Battery	Three 3V Lithium battery CR123
Battery life expectancy	Up to 5 years
Low Battery	2.65V
Operating Temperature	-10°C to +55°C
Dimensions	129.5mm x 67.4mm x 52mm
Weight (incl. battery)	200gr

23

CROW ELECTRONIC ENGINEERING LTD. ("Crow") - WARRANTY POLICY CERTIFICATE

This Warranty Certificate is given in favor of the purchaser (hereunder the "Purchaser") purchasing the products directly from Crow or from its authorized distributor.

Crow warrants these products to be free from defects in materials and workmanship under normal use and service for a period of 12 months from the last day of the week and year whose numbers are printed on the printed circuit board inside these products (hereunder the "Warranty Period").

Subject to the provisions of this Warranty Certificate, during the Warranty Period, Crow undertakes, at its sole discretion and subject to Crow's procedures, as such procedures are from time to time, to repair or replace, free of charge for materials and/or labor, products proved to be defective in materials or workmanship under normal use and service. Repaired products shall be warranted for the remainder of the original Warranty Period. All transportation costs and in-transit risk of loss or damage related, directly or indirectly, to products returned to Crow for repair or replacement shall be borne solely by the Purchaser.

Crow's warranty under this Warranty Certificate does not cover products that is defective (or shall become defective) due to: (a) alteration of the products (or any part thereof) by anyone other than Crow; (b) accident, abuse, negligence, or improper maintenance; (c) failure caused by a product which Crow did not provide; (d) failure caused by software or hardware which Crow did not provide; (e) use or storage other than in accordance with Crow's specified operating and storage instructions.

There are no warranties, expressed or implied, of merchantability or fitness of the products for a particular purpose or otherwise, which extend beyond the description on the face hereof.

This limited Warranty Certificate is the Purchaser's sole and exclusive remedy against Crow and Crow's sole and exclusive liability toward the Purchaser in connection with the products, including without limitation - for defects or malfunctions of the products. This Warranty Certificate replaces all other warranties and liabilities, whether oral, written, (non-mandatory) statutory, contractual, in tort or otherwise.

In no case shall Crow be liable to anyone for any consequential or incidental damages (inclusive of loss of profit, and whether occasioned by negligence of the Crow or any third party on its behalf) for breach of this or any other warranty, expressed or implied, or upon any other basis of liability whatsoever. Crow does not represent that these products can not be compromised or circumvented; that these products will prevent any person injury or property loss or damage by burglary, robbery, fire or otherwise; or that these products will in all cases provide adequate warning or protection.

Purchaser understands that a properly installed and maintained product may in some cases reduce the risk of burglary, fire, robbery or other events occurring without providing an alarm, but it is not insurance or a guarantee that such will not occur or that there will be no personal injury or property loss or damage as a result.

Consequently, Crow shall have no liability for any personal injury; property damage or any other loss based on claim that these products failed to give any warning.

If Crow is held liable, whether directly or indirectly, for any loss or damage with regards to these products, regardless of cause or origin, Crow's maximum liability shall not in any case exceed the purchase price of these products, which shall be the complete and exclusive remedy against Crow.



Electronic Engineering Ltd

12 Kineret St.
Alport City, 70100 Israel
Tel. +972 3 9728000
Fax. +972 3 9728001

sales@crow.co.il
support@crow.co.il

www.thecrowgroup.com

These instructions supersede all previous issues in circulation prior to Dec 2017