

NEO PIR-N

PASSIVE INFRARED DETECTOR With PET IMMUNITY

PRODUCT FEATURES

The NEO PIR-N is a PIR detector, with PET immune, providing protection from intruders by PYRO sensor element.

The NEO PIR-N use Microcontroller for PIR signal analyzing, special ASIC technology for PIR pulse analyzing.

- Quad (Four element) PYRO sensor.
- Hard spherical lens for outstanding detection performance and elimination of false alarms.
- ASIC VLSI based electronics with movement speed spectrum analysis.
- User-friendly installation with or w/o swivel bracket.
- PIR sensitivity adjustment.
- The NEO PIR-N provides pet immunity up to 25Kg. Pet active bellow 1m.
- White light and environmental immunity.

SELECT MOUNTING LOCATION

Choose a location most likely to intercept an intruder. (Our recommendation is a corner installation). See detection pattern fig. 5

The quad-element high quality sensor detects motion crossing the beam; it is slightly less sensitive detecting motion toward the detector.



AVOID THE FOLLOWING LOCATIONS

- Locations where there are large objects in a range of 1m (3ft) from the detector.
- Locations where there are air drafts or substantial airflows.
- Facing direct sunlight.
- Facing areas that may change temperature rapidly or large metal objects.
- Do not install outdoors
- Keep wiring away from electrical power cables.
- Do not install behind partitions.

Note: The NEO PIR-N performs better when provided with a constant and stable environment.

WIRE SIZE REQUIREMENTS

Use #22 AWG (0.5 mm) or wires with a larger diameter. Use the following table to determine required wire gauge (diameter) and length of wire between the detector and the control panel.

Wire Length	m	200	300	400	800
Wire Diameter	mm	.5	.75	1.0	1.5
Wire Length	ft.	656	984	1312	2624
Wire Gauge	AWG	22	20	18	16

FIG. 4 – BRACKET INSTALLATION OPTIONS

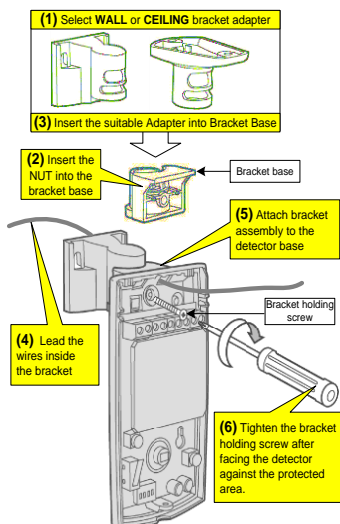

DETECTOR INSTALLATION

The NEO PIR-N can either be wall or corner mounted. If ceiling or special wall mounting is required, use the optional mounting bracket, See fig. 4.

1. To remove the front cover, unscrew the holding screw and gently raise the front cover.



Fig.1 Holding screw

2. To remove the PC board, carefully unscrew the holding screw located on the PC board.
3. Break out the desired holes for proper installation.

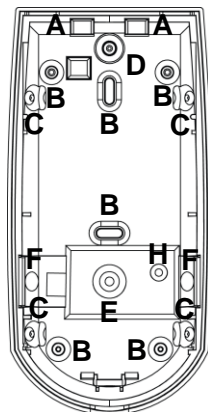
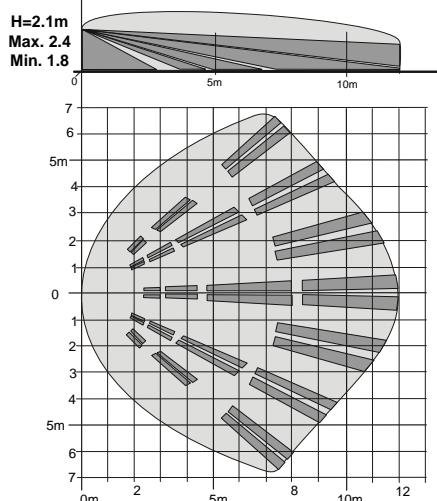

Fig. 2

- For wire access use holes A.
- For flat wall mounting use holes B.
- For corner mounting - use 4 holes C.
- For 45° mounting - use 2 holes C (left or right).
- For bracket mounting use hole D for holding screw.
- For Detector breakage / removal monitoring by back tamper use hole E in flat mounting or F in corner mounting.
- H hole is for the PC board holding screw.

4. The circular and rectangular indentations at the base are the knock-out holes for wire entry. For option with bracket - lead wire through the bracket (see fig. 4)
5. Mount the detector base to the wall, corner or ceiling. (For bracket option see fig.4).
6. Reinstall the PC board by fully tightening the holding screw. Connect wire to terminal block.
7. Replace the cover by inserting it back in the appropriate closing pins and screw in the holding screw.

FIG. 5 - WIDE ANGLE LENS DETECTION PATTERN



CONNECTING THE DETECTOR

The NEO PIR-N might be installed with and without EOL options.

The block connector includes 10 terminals as follow:

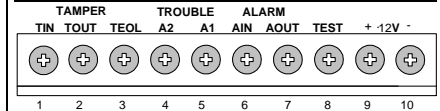

Terminals 9 & 10 - Marked "+ 12V -" : Supply Voltage
Connect to the positive (Voltage supply) and negative (Ground) of the alarm control unit.



Note: The supply connection to the Detectors must only be to a Limited Power Source (LPS) for the input supply in accordance with the Standard EN 60950-1 Latest Revision.

Terminals 8 - Marked "TEST"

This pin is used to enable the LED for walktest when the LED switch "L" is in LED OFF mode. Apply 12VDC to this pin in order to enable the LED activation during walktest.

Terminals 6 & 7 - Marked "ALARM AIN & AOUT"

These are the COMMON and the NC (Normally Closed) outputs of ALARM relay. Connect to the zone input of the alarm control unit.

Terminals 4 & 5 - Marked "TROUBLE A1 & A2"

This terminal is not in use for the NEO-PIR-N

Terminal 3 - Marked "TEOL"

This pin connects the serial EOL resistor to the TAMPER terminals; it is use for connection of more then one detector in serial on the same zone. In this connection only one internal EOL resistor should be used.

Terminals 1 & 2 - Marked "TAMPER TIN & TOUT"

Connect these terminals to a 24-hour normally closed protective zone in the control unit. If the front cover of the detector is opened, an immediate alarm signal will be sent to the control unit.

FIG. 3 - END OF LINE RESISTOR OPTIONS

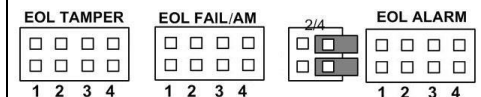

For EOL SETTING please refer to NEO PIR-N on www.thecrowgroup.com

DETECTOR STARTUP

After applying 12Vdc to the (+) and (-) terminals, the NEO PIR-N starts a 30 second warm-up period indicated by alternate flashing the Red, and Green LED's.

Following this sequence the detector is ready.

DETECTOR PC BOARD

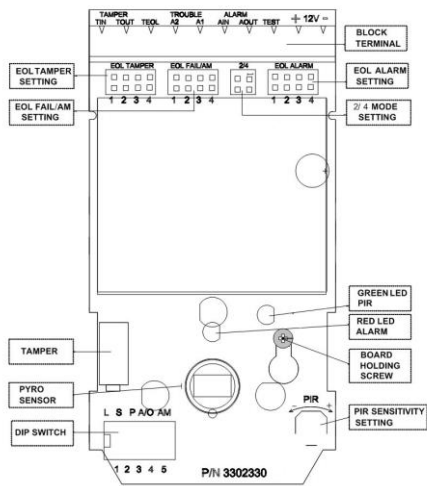

RANGE ADJUSTMENT

"PIR" POTENTIOMETER use for adjustment PIR sensitivity according to protected area range - see fig.5. Rotate the potentiometer clockwise to increase range, counter-clockwise to decrease range.

Note: Range Adjustment change according to installation location and room size.

WALK TESTING

Upon installation, the unit should be thoroughly tested to verify proper operation. The end user should be instructed on how to perform a walk test weekly.

- A. Set DIP Switch-1 to ON position or make sure to trigger the TEST input from Control Panel.
- B. Walk across the detector's field of view in different directions, at various distances from the detector, and verify proper alarming throughout the detector's coverage area, the red LED glows for 2Sec.
- C. When done, remove the cover and set Switch-1 to OFF to prevent unauthorized tracing of the coverage pattern.
- D. Remount the cover and fasten the holding screw.

Note: To assure proper operation, the range and coverage area should be checked at least twice a year.

TECHNICAL SPECIFICATION

Detection Method	Passive Infra Red
Power Input	9 to 16Vdc
Current Draw	Active: 9mA (+/- 5%) Standby: 7mA (+/- 5%)
Temp Consumption	Yes
Alarm Period	2 ± 1 sec
Alarm Outputs	Form A N.C 28Vdc 0.1 A (with 10 Ohm series protection resistor)
Tamper Switch	N.C 28Vdc 0.1 A (with 10 Ohm Resistors) open on cover removal
Warm up Period	30 sec
Operation Temp	-10°C ~ +50 °C (14 °F~122 °F)
Dimensions	123.5mm x 61.5mm x 40mm
Weight	102gr.
Part Number	0029304

SETTING UP THE DETECTOR

There are 5 DIP switches on the NEO PIR-N PC board that enable setting of following functions:

Note: Marked (**) positions are the factory default setting of the detector.

Switch 1 – Marked L - LED Enable

Use for setting LED Enable / Disable
**** ON Position (Up)** – all LED's enabled.
OFF Position (Down) – all LED's disabled.
Note: the state of the switch "LED" does not affect the operation of the ALARM and TROUBLE relays.

Switch 2 – Marked S - PIR SENSITIVITY Setting

Use for setting PIR sensitivity control according to the environment.
**** ON Position (Up)** - High sensitivity for stable environments.
OFF Position (Down) - Low sensitivity for harsh environments.

Switch 3 – Marked P - PET IMMUNITY Setting

Use for setting the PET Immune function 12Kg or 25Kg, depending on the pet Weight.
**** ON Position (Up)** - Immunity to an animal up to 12kg.
OFF Position (Down) - Immunity to an animal up to 25kg.

Switch 4 & 5 – NOT IN USE

These switches are in use only for models Neo DT-N, Neo PIR-AM-N and Neo DT-AM-N

VISIBLE LIGHT FILTER OPTION

Use the optional white light filter in order to improve the detector stability to high intensity visible light (not for EN50131 installations).

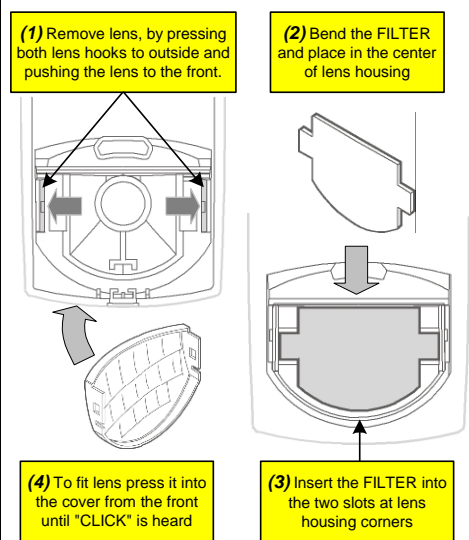

LED VISUAL INDICATIONS

There are two LED's on the unit's PC board to signal various detector events:

Event Message	RED	GREEN
Initial warm-up (30Sec.)		
No Detection Standby		
ALARM		

WARRANTY

CROW ELECTRONIC ENGINEERING LTD. ("Crow") - WARRANTY POLICY CERTIFICATE

This Warranty Certificate is given in favor of the purchaser (hereunder the "Purchaser") purchasing the products directly from Crow or from its authorized distributor. Crow warrants these products to be free from defects in materials and workmanship under normal use and service for a period of 24 months from the last day of the week and year whose numbers are printed on the printed circuit board inside these products (hereunder the "Warranty Period").

Subject to the provisions of this Warranty Certificate, during the Warranty Period, Crow undertakes, at its sole discretion and subject to Crow's procedures, as such procedures are from time to time, to repair or replace, free of charge for materials and/or labor, products proved to be defective in materials or workmanship under normal use and service. Repaired products shall be warranted for the remainder of the original Warranty Period.

All transportation costs and in-transit risk of loss or damage related, directly or indirectly, to products returned to Crow for repair or replacement shall be borne solely by the Purchaser. Crow's warranty under this Warranty Certificate does not cover products that is defective (or shall become defective) due to: (a) alteration of the products (or any part thereof) by anyone other than Crow; (b) accident, abuse, negligence, or improper maintenance; (c) failure caused by a product which Crow did not provide; (d) failure caused by software or hardware which Crow did not provide; (e) use or storage other than in accordance with Crow's specified operating and storage instructions.

There are no warranties, expressed or implied, of merchantability or fitness of the products for a particular purpose or otherwise, which extend beyond the description on the face hereof. This limited Warranty Certificate is the Purchaser's sole and exclusive remedy against Crow and Crow's sole and exclusive liability toward the Purchaser in connection with the products, including without limitation - for defects or malfunctions of the products. This Warranty Certificate replaces all other warranties and liabilities, whether oral, written, (non-mandatory) statutory, contractual, in tort or otherwise.

In no case shall Crow be liable to anyone for any consequential or incidental damages (inclusive of loss of profit, and whether occasioned by negligence of the Crow or any third party on its behalf) for breach of this or any other warranty, expressed or implied, or upon any other basis of liability what so ever. Crow does not represent that these products can not be compromised or circumvented; that these products will prevent any person injury or property loss or damage by burglary, robbery, fire or otherwise; or that these products will in all cases provide adequate warning or protection.

Purchaser understands that a properly installed and maintained product may in some cases reduce the risk of burglary, fire, robbery or other events occurring without providing an alarm, but it is not insurance or a guarantee that such will not occur or that there will be no personal injury or property loss or damage as a result.

Consequently, Crow shall have no liability for any personal injury; property damage or any other loss based on claim that these products failed to give any warning.

If Crow is held liable, whether directly or indirectly, for any loss or damage with regards to these products, regardless of cause or origin, Crow's maximum liability shall not in any case exceed the purchase price of these products, which shall be the complete and exclusive remedy against Crow.

STANDARDS COMPLIANCE

European Council Directive 2004/108/EC
 EN50130-4+A1+A2
 EN301489-3
 EN301489-1
 EN61000-6-3
 EN50131-6
 EN50130-5
 SAFETY LVD 2006/95/EC , EN60950-1 (93/68/EEC)
 EN50131-1, EN50131-2-2
 Security Grade 2, Environmental Class II

For more detailed instruction please refer the manuals which you could download from the internet at: www.thecrowgroup.com



CROW ELECTRONIC ENGINEERING LTD.



Crow Electronic Engineering Ltd.
 12 Kineret St. Airport City
 P.O. Box 293, Ben Gurion Airport, 70100
 Israel
 Tel: +972-3-9726000
 Fax: +972-3-9726001
 E-mail: support@crow.co.il

These instructions supersede all previous issues in circulation prior to November 2015