

DECT ULE-MAG

MAGNETIC CONTACT

CR-DU-MAG
CR-DU-MAG USA



ELECTRONIC ENGINEERING LTD.

INSTALLATION INSTRUCTIONS
P/N 7105190 REV. A (O.Z.)

OPERATION

The DECT ULE MAG detector transmits the following events data:

KEEP ALIVE – A periodical transmission indicating detector's presence. The time interval is configurable – the minimum value is 1 minute.

ALARM – Alarm transmission triggered by the device indicating intrusion detection.

LOW BAT – Whenever the battery reaches a pre-set low level (~2.5V) Battery Low signal will be sent. When Battery level drops below Cut Off level (~2.3V) the device will stop functioning and the Red LED will constantly light On.

TAMPER – Whenever the cover is removed from Bracket or the device is tear off from the wall, a message will be transmitted with "Tamper ON" signal. When cover will be returned a "Tamper OFF" signal will be transmitted.

PAIRING PROCESS

1. Open the screw cover and unscrew the holding screw as shown in Figure 1.
2. Separate the device from the Bracket by tilting the front cover as shown in Figure 1.
3. Place a battery as instructed in Figure 2 and wait until the Red LED stops blinking.
4. Initiate the Base Station pairing process.
5. Initiate the device pairing process by pressing the pairing button for 5 seconds – the pairing button is shown in Figure 3. The Green LED will constantly turn On. When the Green LED starts blinking release the pairing button.
6. The device should register to the Base Station.
7. When registration process is successfully completed the Green LED will constantly light On for 3 seconds and then turn off.
8. If registration process failed the Red LED will blink (remove the battery and run the pairing process again).

FIGURE 4 – WAY OF INSTALLATION

DECT ULE-MAG

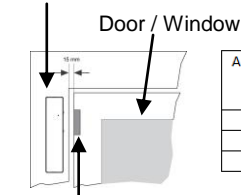

Axis	Approach Distance [mm]	Break Distance [mm]
X	14	15
Y	14	15
Z	14	15

Magnet unit

Opening Direction Axis:

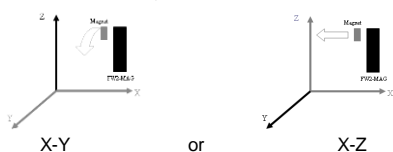

INTRODUCTION

This DECT ULE MAG detector is an advanced, fully supervised low-current wireless detector that includes a DECT ULE transceiver for reliable system operation.

A built-in reed switch is applied in this device.

This DECT ULE MAG uses smart message control, which verifies that all messages are successfully transmitted, so that no intrusion event will be uninformed to the system.

This DECT ULE MAG detector includes series of messages for full communication administration (Keep Alive, Tamper Status, Battery Status, Alert, Configuration, etc.) as well as test transmission signals.

FIGURE 1 – SEPARATE FROM BRACKET

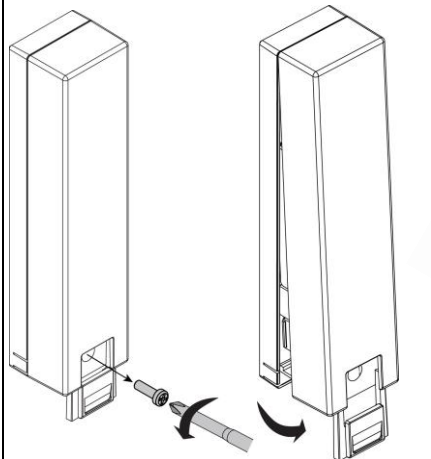
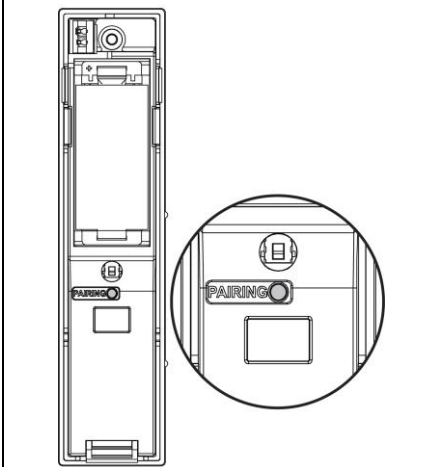

FIGURE 3 - PAIRING



WAY OF INSTALLATION

It is recommended to mount the device vertically on a flat area to get maximum range.

It is recommended to attach the transmitter to the fixed frame and the small magnet to the moveable part (door or window), as shown on Figure 4.

It is very important to mount the small Magnet part as closes as possible to the transmitter part and in the correct location.

On the transmitter there are 2 knobs emphasizing the relatively correct location of the small magnet – see Figure 5.

The height of the small magnet relatively to the transmitter part should be no more than 10mm lower or higher or to the side of the transmitter. This, of course, depend the Window / Door structure.

Figures 5 illustrate one option of installation.

FEATURES

- DECT ULE RF protocol.
- Low current Technology.
- Powered by a single 3V Lithium battery.
- Battery life: up to 4 years.
- Frequency Band: All DECT Standard Bands.
- Contact Open/Close transmission.
- Tamper Open/Close transmission.
- Keep Alive transmission.
- Battery status transmission.
- Bi-Color LED indications for monitoring & Pairing.
- Range up to 500m on open space.
- Back tamper.
- Alarm trigger by an internal reed switch.
- Remotely configurable.
- Friendly Pairing and Installation processes.

FIGURE 2 – BATTERY PLACEMENT

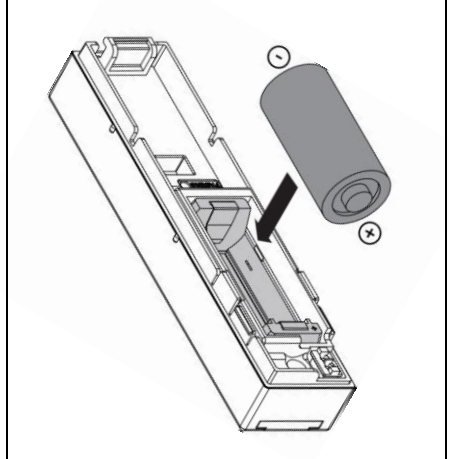

SELECT MOUNTING LOCATION

As the device is a wireless transceiver, and in order to take full advantage of it's sophisticated operation, do not install the detector in areas where large metal objects could interfere with the transmission of signals.

Installation is not allowed on a ferromagnetic surface.

FIGURE 5 – MOUNTING THE DEVICE

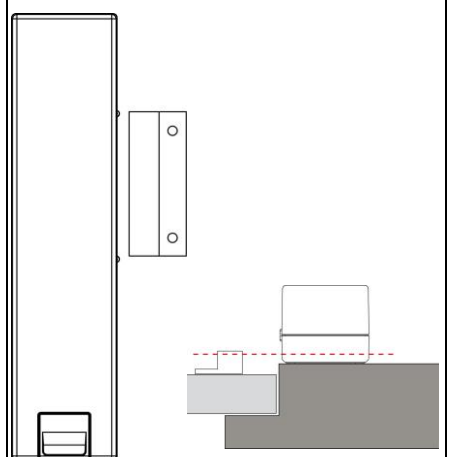

MOUNTING THE DEVICE

1. Open the screw cover and unscrew the holding screw as shown in Figure 1.
2. Separate the device from the Bracket by tilting the front cover as shown in Figure 1.
3. Mount the Bracket to the wall: place 3 screws and make sure you tighten the tamper screw - the middle screw - as shown in Figure 6.
4. Mount the small Magnet part on the moveable part (door or window), as shown in Figures 4.
5. Validate that the battery was inserted and the device is paired with the Base Station. Use the small magnet to generate Open / Close Alert indication.
6. Place the device in the Bracket by inserting it back into its appropriate position - as shown in Figure 1.
7. Fasten the holding screw and close the screw cover.

16

BATTERY REPLACEMENT

1. Open the screw cover and unscrew the holding screw as shown in Figure 1.
2. Separate the device from the Bracket by tilting the front cover as shown in Figure 1.
3. Remove the in used battery from the device.
4. Install the new battery in the correct polarity marking - as seen in Figure 2.
5. Wait until the Red LED stops blinking.
6. In case the device was paired to a Base Station the device should automatically register again to the same Base Station and the Green LED shall constantly light On for 3 seconds.
7. Place the device in the Bracket by inserting it back into appropriate position and validate receiving the Tamper Alert Off indication on your Application / Base Station.
8. Fasten the holding screw and close the screw cover.

19

REGULATORY APPROVALS

This DECT ULE MAG detector conforms to the essential requirements set out by:

- RTTE directive: 1999/5/EC
- EMC directive: 2004/108/EC
- Low Voltage directive: 2006/95/EC
- RoHS directive: 2011/65/EU

Harmonized Standards applicable to this products are:

- EN301406
- EN301489-6
- EN301489-1
- EN61000-6-3
- EN60950-1
- EN50581



22

CROW ELECTRONIC ENGINEERING LTD. ("Crow") - WARRANTY POLICY CERTIFICATE

This Warranty Certificate is given in favor of the purchaser (hereunder the "Purchaser") purchasing the products directly from Crow or from its authorized distributor.

Crow warrants these products to be free from defects in materials and workmanship under normal use and service for a period of 24 months from the last day of the week and year whose numbers are printed on the printed circuit board inside these products (hereunder the "Warranty Period").

Subject to the provisions of this Warranty Certificate, during the Warranty Period, Crow undertakes, at its sole discretion and subject to Crow's procedures, as such procedures are from time to time, to repair or replace, free of charge for materials and/or labor, products proved to be defective in materials or workmanship under normal use and service. Repaired products shall be warranted for the remainder of the original Warranty Period. All transportation costs and in-transit risk of loss or damage related, directly or indirectly, to products returned to Crow for repair or replacement shall be borne solely by the Purchaser.

Crow's warranty under this Warranty Certificate does not cover products that is defective (or shall become defective) due to: (a) alteration of the products (or any part thereof) by anyone other than Crow; (b) accident, abuse, negligence, or improper maintenance; (c) failure caused by a product which Crow did not provide; (d) failure caused by software or hardware which Crow did not provide; (e) use or storage other than in accordance with Crow's specified operating and storage instructions.

There are no warranties, expressed or implied, of merchantability or fitness of the products for a particular purpose or otherwise, which extend beyond the description on the face hereof.

This limited Warranty Certificate is the Purchaser's sole and exclusive remedy against Crow and Crow's sole and exclusive liability toward the Purchaser in connection with the products, including without limitation - for defects or malfunctions of the products. This Warranty Certificate replaces all other warranties and liabilities, whether oral, written, (non-mandatory) statutory, contractual, in tort or otherwise.

In no case shall Crow be liable to anyone for any consequential or incidental damages (inclusive of loss of profit, and whether occasioned by negligence of the Crow or any third party on its behalf) for breach of this or any other warranty, expressed or implied, or upon any other basis of liability whatsoever. Crow does not represent that these products can not be compromised or circumvented; that these products will prevent any person injury or property loss or damage by burglary, robbery, fire or otherwise; or that these products will in all cases provide adequate warning or protection.

Purchaser understands that a properly installed and maintained product may in some cases reduce the risk of burglary, fire, robbery or other events occurring without providing an alarm, but it is not insurance or a guarantee that such will not occur or that there will be no personal injury or property loss or damage as a result.

Consequently, Crow shall have no liability for any personal injury; property damage or any other loss based on claim that these products failed to give any warning.

If Crow is held liable, whether directly or indirectly, for any loss or damage with regards to these products, regardless of cause or origin, Crow's maximum liability shall not in any case exceed the purchase price of these products, which shall be the complete and exclusive remedy against Crow.

FIGURE 6 – MOUNTING THE DEVICE

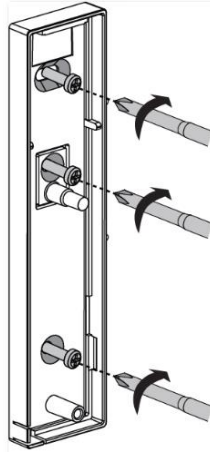

17

Reserved

TRANSMISSION TESTS

Tamper transmission test –

Changing the tamper switch state (by attaching / removing the device to / from the Bracket) will cause tamper transmissions. Verify receiving the indication on your Application / Base Station.

Open/Close transmission test –

Removing / Placing the small magnet from / to the device will cause Open / Close alert transmission. Verify receiving the indication on your Application / Base Station.

Identification transmission test –

Use your Application / Base Station and send Identification Request to the device. The device will start blinking the Green & Red LEDs alternately – 5 times each LED starting with the Green LED.

18

Reserved

20

TECHNICAL SPECIFICATIONS

RF Protocol	DECT ULE Standard
Modulation Type	GFSK
Frequency	1880–1900 MHz - Europe 1920–1930 MHz - USA/Canada
Event Transmission	Alarm, Tamper, Keep Alive, Battery status.
Detection Method	Internal Reed Switch
Range in open space	>500m
Battery	Lithium 3V Type: CR123A Size: 2/3A
Battery life	>5 years (10 activation per day)
Current Consumptions:	
Standby	8µA
Average	23µA
Maximum (TX)	250mA
Low Battery	2.5VDC
Cut Off Battery	2.3VDC
Transmit Power (Typ.):	23dBm (EURO), 20dBm (USA)
Tamper Switch	Back Tamper
Operating temperature	-10°C to +55°C
Dimensions	104mm x 24mm x 22mm
Weight (inc. magnet)	45 gr.
Weight (inc. battery)	60 gr.

20

CAUTION !!!

RISK OF EXPLOSION IF BATTERY IS

REPLACED BY DIFFERENT TYPE /
MODEL.

DISPOSE USED BATTERIES
ACCORDING TO ITS INSTRUCTIONS

*The battery must be
replaced by 3V Lithium
battery Size 2/3A
Models such as:*

1. VARTA CR123A
2. GP CR123A

23

CROW ELECTRONIC ENGINEERING LTD.

12 Kineret St.
Airport City, 70100 Israel
Tel. +972 3 9726000
Fax. +972 3 9726001
sales@crow.co.il
support@crow.co.il
www.thecrowgroup.com

CROW LATIN AMERICA USA INC.

7200 NW 19 st.
Suite 307
Miami FI 33126, USA
Tel. +305 513 4001
Fax. +305 513 4005
rejana@crowlatinamerica.com
www.crowlatinamerica.com